

# SCHEDA TECNICA / TECHNICAL DATA

RUBINETTERIE RITMONIO S.R.L. si riserva tutti i diritti connessi con il presente documento e con l'oggetto o la materia ivi rappresentati con divieto di riprodurlo, utilizzarlo o renderlo accessibile a terzi in assenza di previa autorizzazione. Disegno CAD non modificabile a mano

RUBINETTERIE RITMONIO S.R.L. will claim all rights related to the present document and with the object or subject represented therein with the prohibition of reproduction, use or disclosure to third parties without previous permission. The Cad plan is not alterable by hand

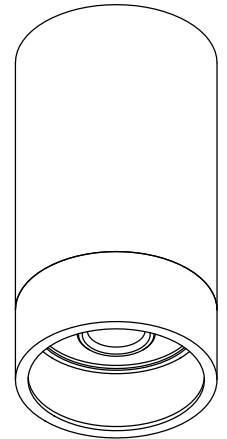
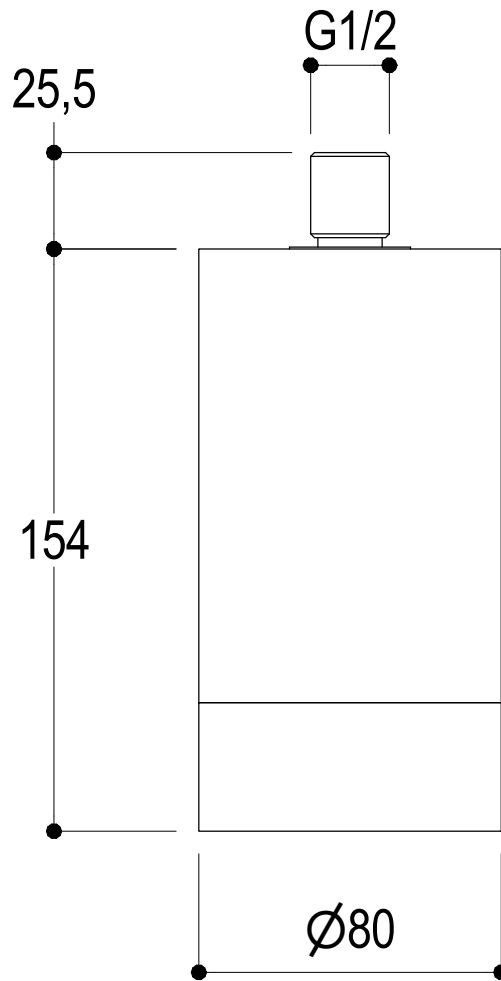

Vista ISO

**Ritmonio**  
Living a quality experience.  
13019 VARALLO - (VC) - ITALY

SERIE  
DIAMETRO35 WELLNESS

CODICE  
PR5575TA01

DATA EMISSIONE  
29/06/2022

DENOMINAZIONE  
Soffione per doccia da soffitto  
Ceiling showerhead

REVISIONE  
/

# SCHEDA TECNICA / TECHNICAL DATA

RUBINETTERIE RITMONIO S.R.L. si riserva tutti i diritti connessi con il presente documento e con l'oggetto o la materia ivi rappresentati con divieto di riprodurlo, utilizzarlo o renderlo accessibile a terzi in assenza di previa autorizzazione. Disegno CAD non modificabile a mano

RUBINETTERIE RITMONIO S.R.L. will claim all rights related to the present document and with the object or subject represented therein with the prohibition of reproduction, use or disclosure to third parties without previous permission. The Cad plan is not alterable by hand

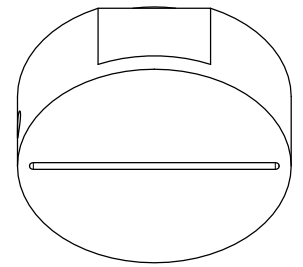

Vista ISO

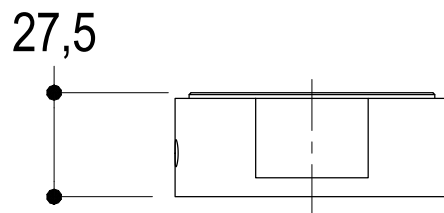
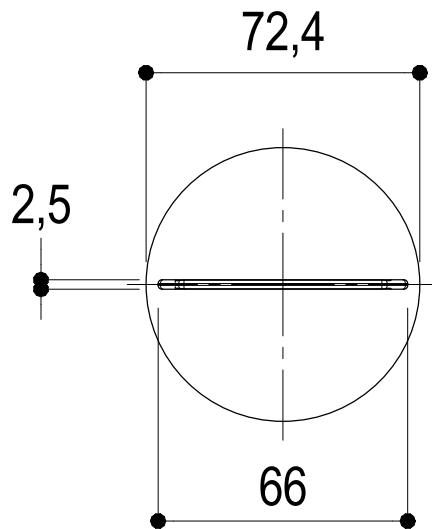

**Ritmonio**  
Living a quality experience.  
13019 VARALLO - (VC) - ITALY

SERIE  
Ø35 WELLNESS IMPRONTE

CODICE  
PR55PB 301

DATA EMISSIONE  
13/06/2022

DENOMINAZIONE  
Getto Blade  
Blade jet

REVISIONE  
/

# SCHEDA DI PORTATA / FLOW RATE DATA

RUBINETTERIE RITMONIO S.R.L. si riserva tutti i diritti connessi con il presente documento e con l'oggetto o la materia ivi rappresentati con divieto di riprodurlo, utilizzarlo o renderlo accessibile a terzi in assenza di previa autorizzazione. Disegno CAD non modificabile a mano

RUBINETTERIE RITMONIO S.R.L. will claim all rights related to the present document and with the object or subject represented therein with the prohibition of reproduction, use or disclosure to third parties without previous permission. The Cad plan is not alterable by hand



Living a quality experience.

13019 VARALLO - (VC) - ITALY

*I diagrammi riportati di seguito riassumono i valori riscontrati durante le prove di portata dei seguenti articoli. Le prove sono state effettuate con pressioni che variavano da 1 a 5 bar e in posizione di acqua miscelata*

*The following diagrams sum up the values, taken from flow tests of the following items. Tests were conducted with pressure variations from 1 to 5 bar and with mixed water.*

## DIAMETRO35 WELLNESS

### Art. PR55PB301

Getto Blade

Blade Jet

Portata con aeratore  
Flow rate with aerator

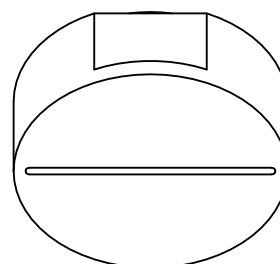
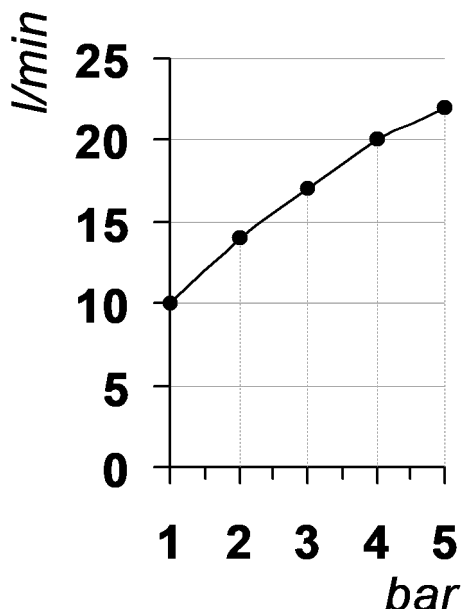

bar	1	2	3	4	5
l/min	10	14	17	20	22

REVISIONE

/

DATA EMISSIONE

12/07/2022