

DIAMETRO 35 s

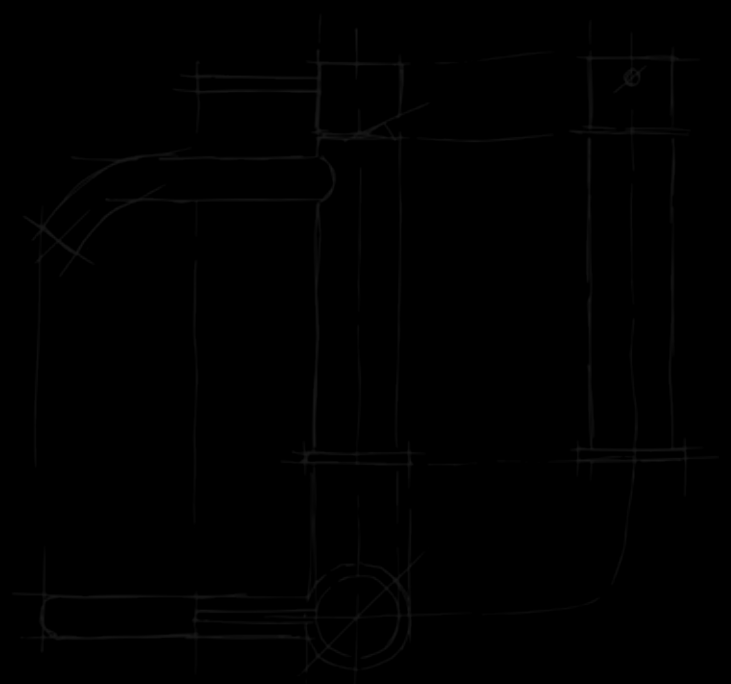

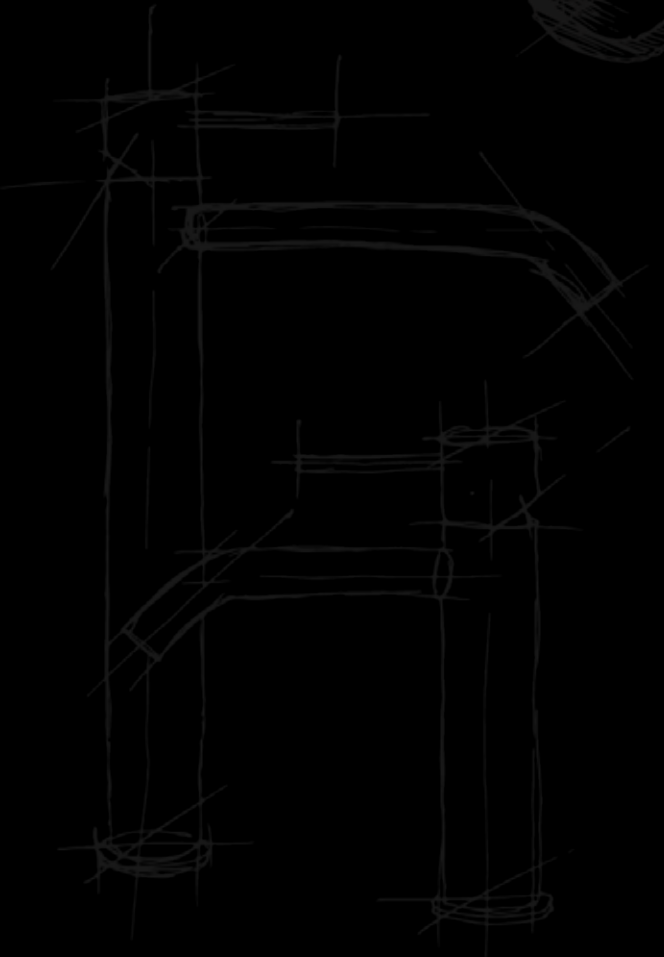
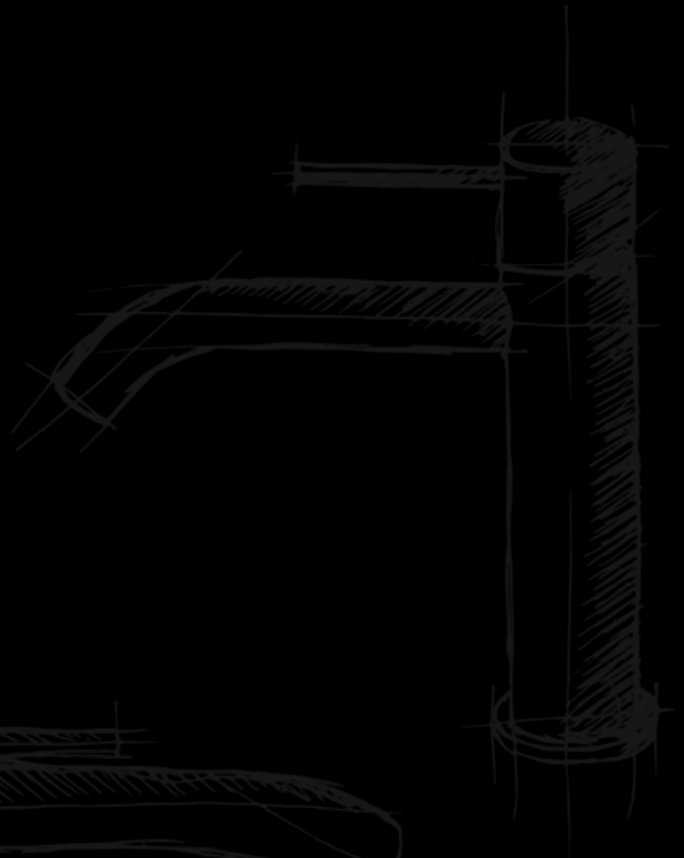
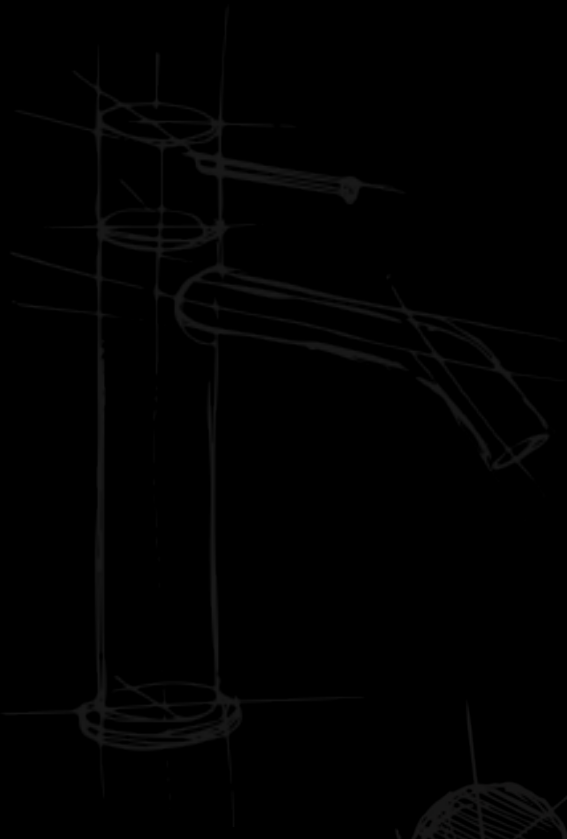

SMART, SEMPLICE, SORPRENDENTE:

RITMONIO PRESENTA

DIAMETRO35 s

UN CLASSICO CHE SI EVOLVE

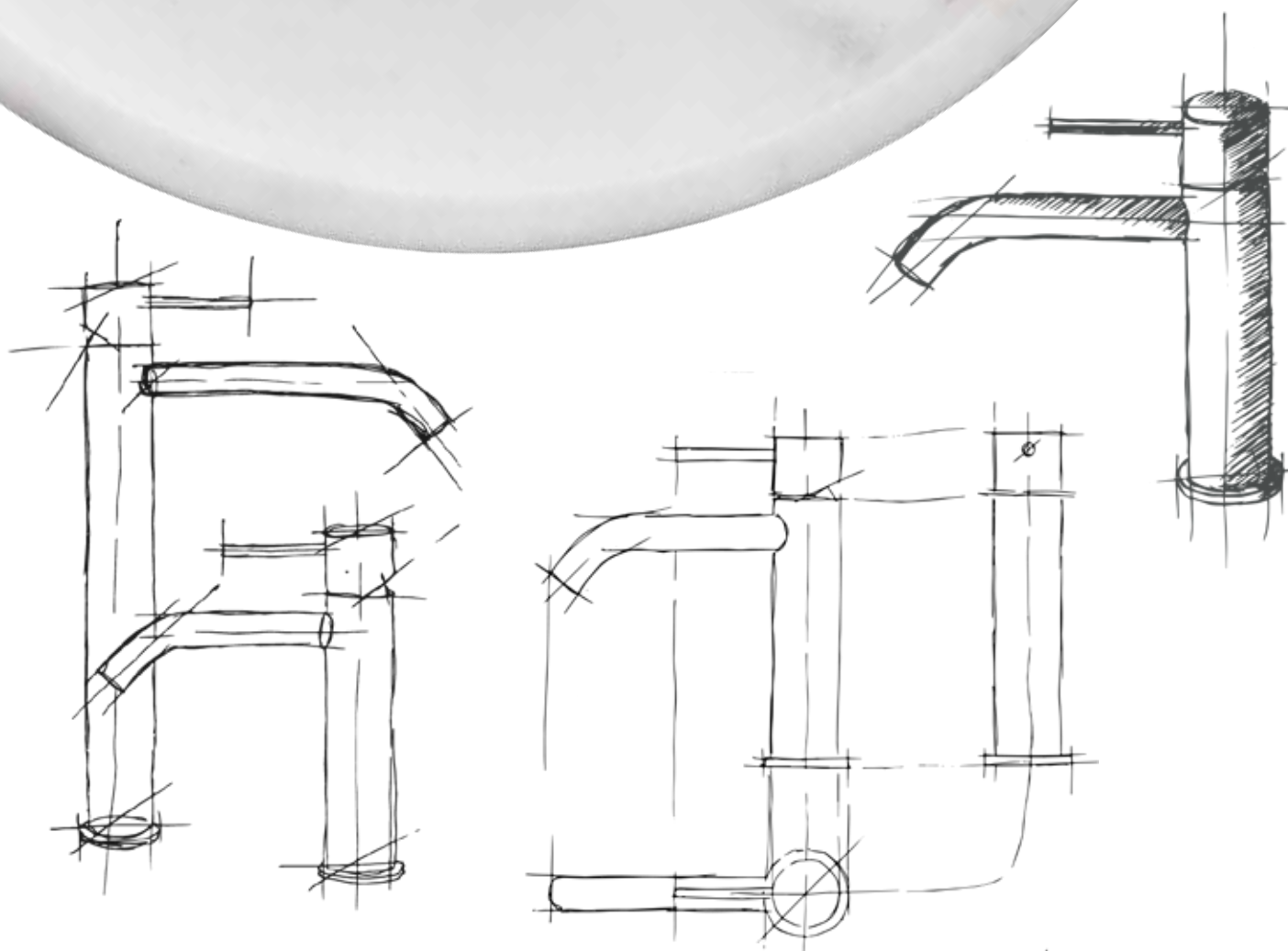

Smart, simple, surprising: Ritmonio presents DIAMETRO35 S, a classic that is evolving.

Smart, simple, surprenant: Ritmonio présente DIAMETRO35 S, un classique qui évolue.

Smart, simple, sorpredente: Ritmonio presenta DIAMETRO35 S, un clasico que evoluciona.

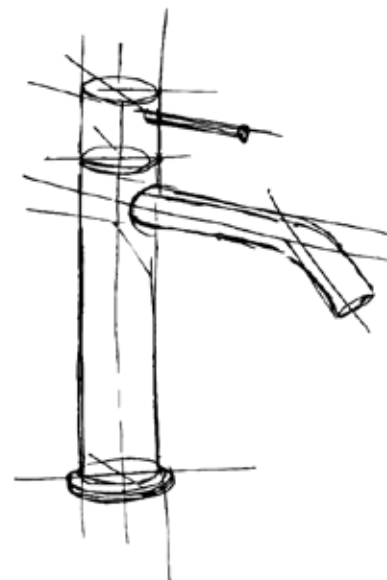

DIAMETRO35 s

VERSATILE, GIOVANE E INNOVATIVA
IN FATTO DI CONFIGURAZIONI,
FINITURE E AMPIEZZA DI GAMMA
ASSECONDA RICHIESTE
ESTETICHE ESIGENTI
E CREATIVE

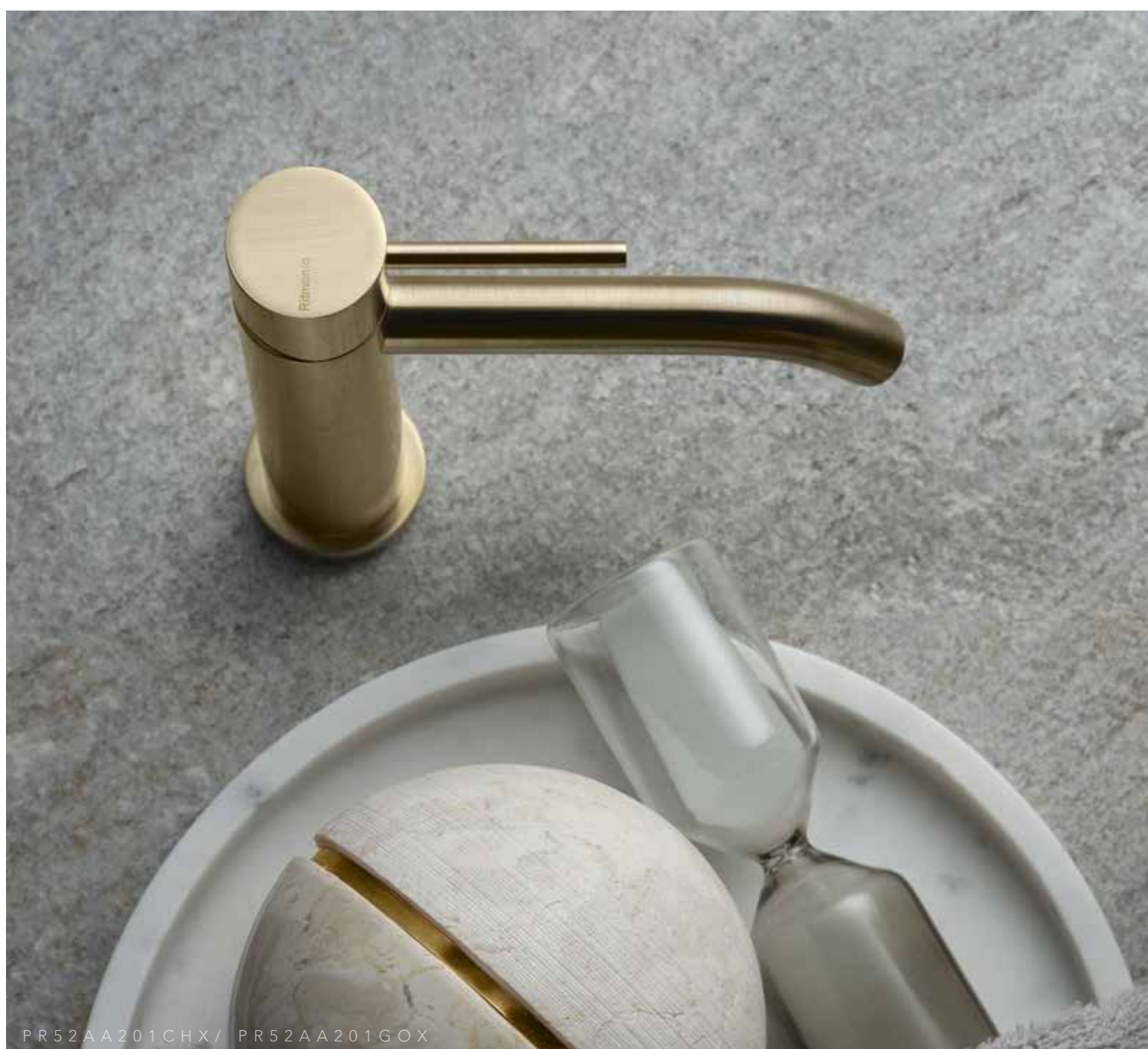

PR52AA201CHX/ PR52AA201GOX

DIAMETRO35 S - UN CLASSICO CHE SI EVOLVE

DIAMETRO35 S

Versatile, young and innovative in terms of configurations, finishes and width of range, satisfies the increasingly demanding requests in terms of aesthetic and creativity

DIAMETRO35 S

Polyvalente, jeune et innovante en matière de configurations, de finitions et d'amplitude de gamme, cède aux demandes esthétiques exigeantes et créatives

DIAMETRO35 S

Versátil, joven e innovadora en cuanto a configuraciones, acabados y amplitud de gama, apoya las exigencias estéticas y creativas



Configurable in the 16 special finishes of the Ritmonio Finishes Selection, it allows a high level of customization and interprets the style of each interior project.

Configurable dans les 16 finitions spéciales de la Ritmonio Finishes Selection, la ligne permet un haut niveau de personnalisation et interprète le style de chaque projet d'intérieur.

Configurable en los 16 acabados especiales de la Ritmonio Finishes Selection, permite un alto nivel de personalización e interpreta el estilo de cada proyecto interior.



PR52AF201IX/PR52AA201BLX

CONFIGURABILE
NELLE 16 FINITURE
SPECIALI DELLA
RITMONIO FINISHES
SELECTION, CONSENTE
UN ELEVATO LIVELLO DI
PERSONALIZZAZIONE
E INTERPRETA LO STILE
DI OGNI PROGETTO
INTERIOR.

Ø35
S





PR52AH102IX
7BW002IX/7BW002IX/7L0003IX/7GS004IX

DIAMETRO35 S - UN CLASSICO CHE SI EVOLVE

SMART SEMPLICE SOPRENDENTE

SEMPLICITA' E LINEARITA' RENDONO LA COLLEZIONE UNICA: LE PROPORZIONI DEGLI ELEMENTI, ISPIRATE ALLA PERFEZIONE DI DIAMETRO 35, NE CONSERVANO FUNZIONALITA' ED ESTETICA DANDO VITA AD UN PRODOTTO ESTREMAMENTE EQUILIBRATO ED INTELLIGENTE, CHE SI DIFFERENZIA PER QUALITA' E PRESTAZIONI IN UN AMBIENTE, COME QUELLO DEL BAGNO, IN CUI ANCHE LA COMPONENTE TECNICA RISULTA MOLTO IMPORTANTE.



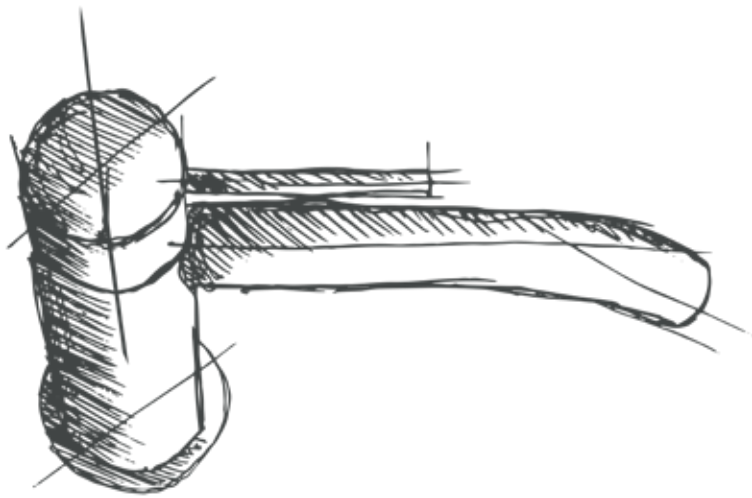

PR52LA221IX/PR52FB201IX

DIAMETRO35 S - UN CLASSICO CHE SI EVOLVE

**SMART
SIMPLE
AMAZING**

Simplicity and linearity make the collection unique: the proportions of the elements, inspired by the perfection of Diametro35, preserve its functionality and aesthetics, giving life to an extremely balanced and intelligent product, which differs in terms of quality and performance in an environment, such as the bathroom, in which the technical component is also very important.

**SMART
FACILE
INCROYABLE**

Simplicité et linéarité rendent la collection unique : les proportions des éléments, inspirées de la perfection de Diametro35, en conservent la fonctionnalité et l'esthétique, en donnant vie à un produit extrêmement équilibré et intelligent, qui arrive à se distinguer par la qualité et les performances dans un environnement, comme celui de la salle de bain, où la composante technique est également très importante.

**SMART
SIMPLE
INCREDIBLE**

Simplicidad y linealidad hacen la colección única: las proporciones de los elementos, inspiradas por la perfección de Diametro35, conservan su funcionalidad y estética, dando vida a un producto extremadamente equilibrado e inteligente, que difiere en calidad y rendimiento en un ambiente, como el del baño, en el que también el componente técnico es muy importante.



PR52EG201IX
7BW002IX/7BW002IX/7L0005IX/7N0004F38



DIAMETRO35 s

COME TUTTI I PRODOTTI RITMONIO, DIAMETRO35 S NASCE DA UN'ATTENZIONE SCRUPOLOSA ALLA GESTIONE DELLE RISORSE, PER LA QUALE L'AZIENDA SI IMPEGNA IN PRIMA LINEA PROGETTANDO ESCLUSIVAMENTE PRODOTTI A RIDOTTO CONSUMO IDRICO E PROMUOVENDO UN UTILIZZO RESPONSABILE DELLE RISORSE NATURALI, CHE SI TRADUCE IN RISPARMIO E ABBATTIMENTO DEI CONSUMI.



DIAMETRO35 S

As all Ritmonio products, Diametro35 S is born from a scrupulous attention to the management of natural resources, for which the company is committed by designing products with reduced water consumption and promoting a responsible use of natural resources, which means savings and reduction of consumption.

DIAMETRO35 S

Comme tous les produits Ritmonio, Diametro35 S, est née d'une attention minutieuse à la gestion des ressources, pour laquelle l'usine s'engage en projetant exclusivement des produits à faible consommation d'eau et en promouvant une utilisation responsable des ressources environnementales, qui se traduit par économie de la consommation.

DIAMETRO35 S

Como todos los productos Ritmonio, Diametro35 S nace de una atención escrupulosa por la gestión de los recursos, por la cual la Empresa se compromete en primera línea proyectando exclusivamente productos de bajo consumo de agua y promoviendo una utilización responsable de los recursos naturales, que se traduce en ahorro y reducción del consumo.